

buiten

binnen

Kaderprofiel: Deventer b.v.t.

█ Grafiet opsch. band 2x20mm



maten
in mm
sept.
2013

pas- en arm
met kader
30 min. b.v.t.
54mm dik
binnendraaiend

Blad:
954

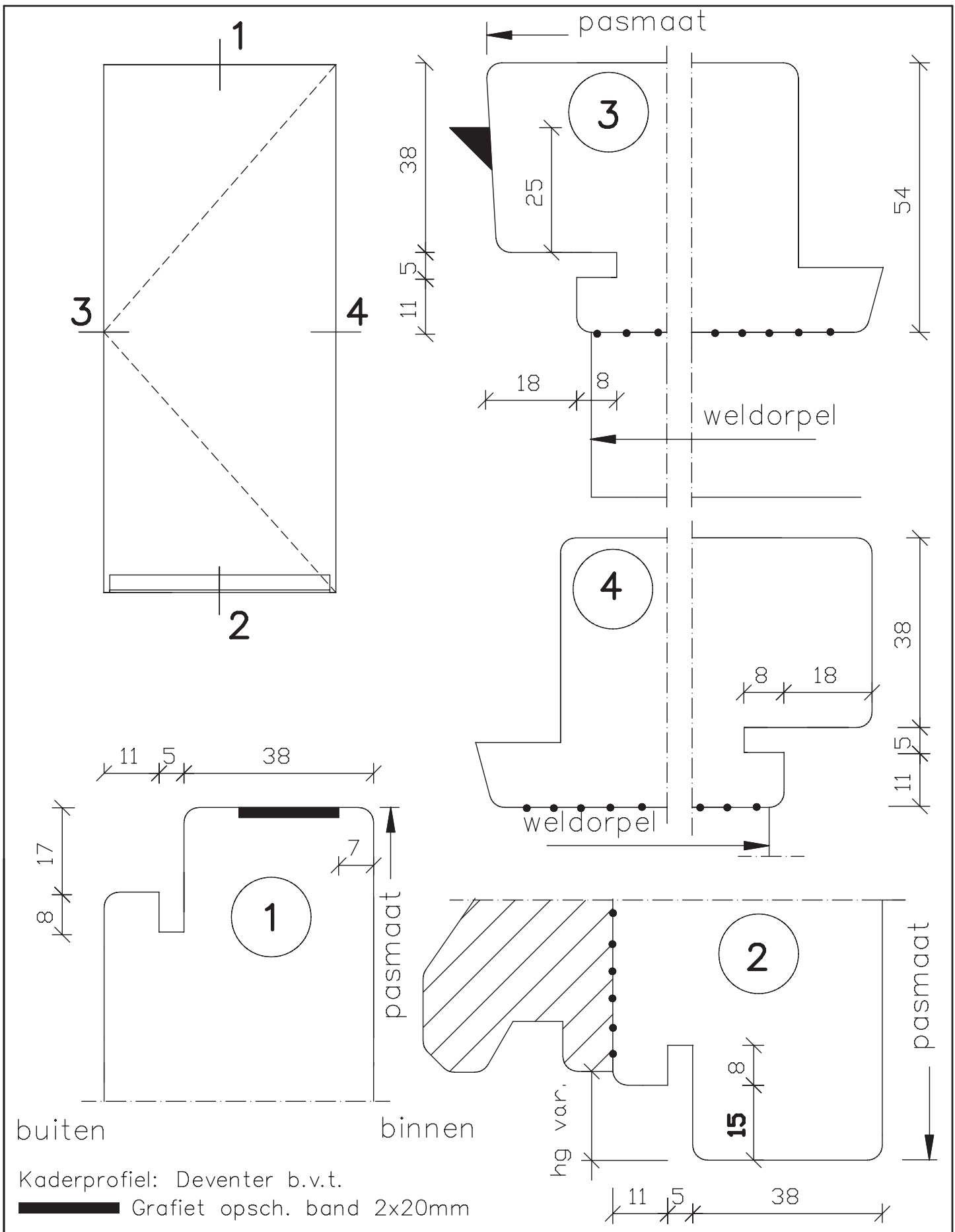

Kaderprofiel: Deventer b.v.t.
 Grafiet opsch. band 2x20mm



	pas- en arm met kader 30 min. b.v.t. 54mm dik binnendraaiend	Blad:
maten in mm		954
sept. 2013		H

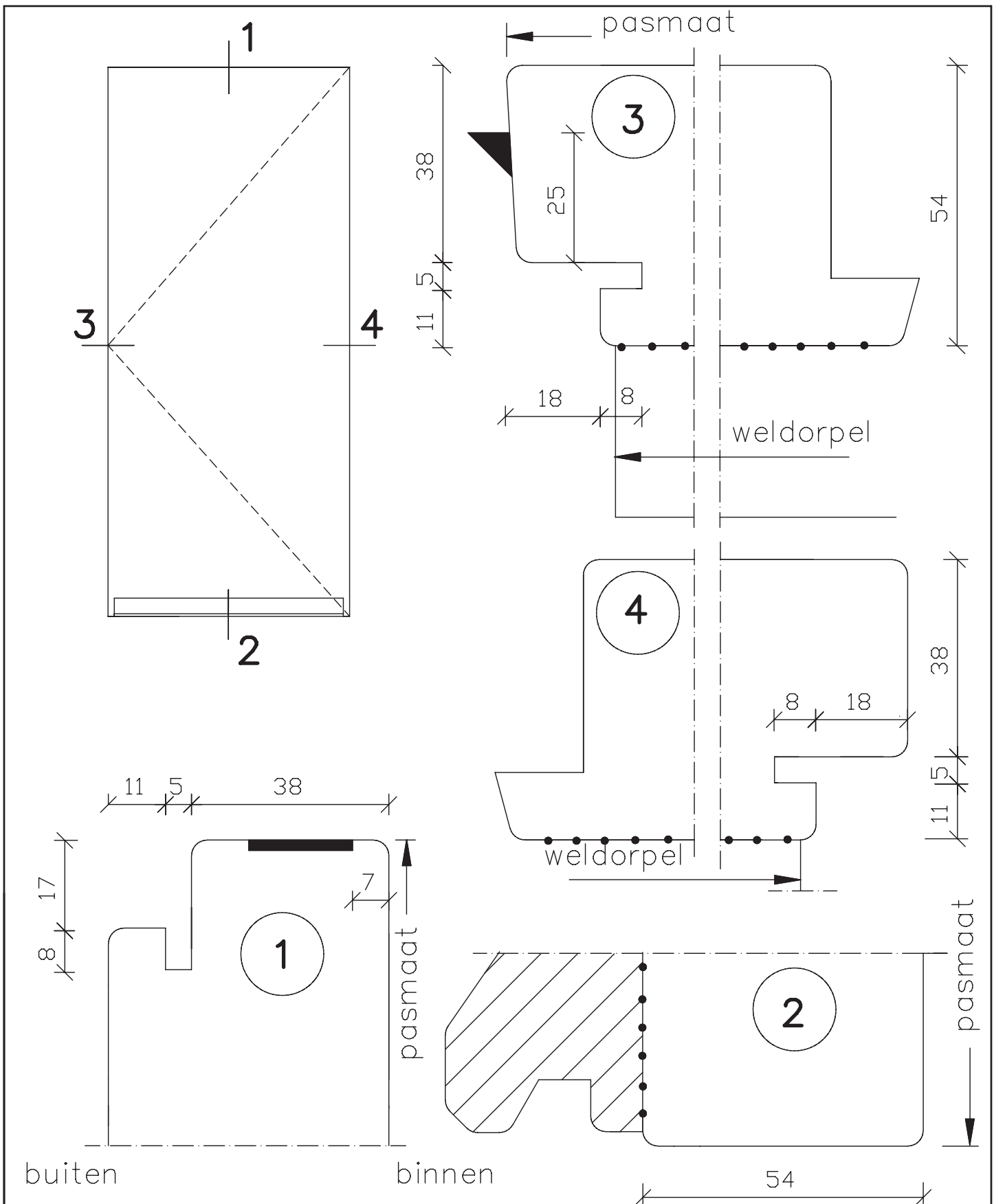

Kaderprofiel: Deventer b.v.t.
 Grafiet opsch. band 2x20mm



	pas- en arm met kader 30 min. b.v.t.	Blad: 954
maten in mm	54mm dik binnendraaiend	S
sept. 2013		

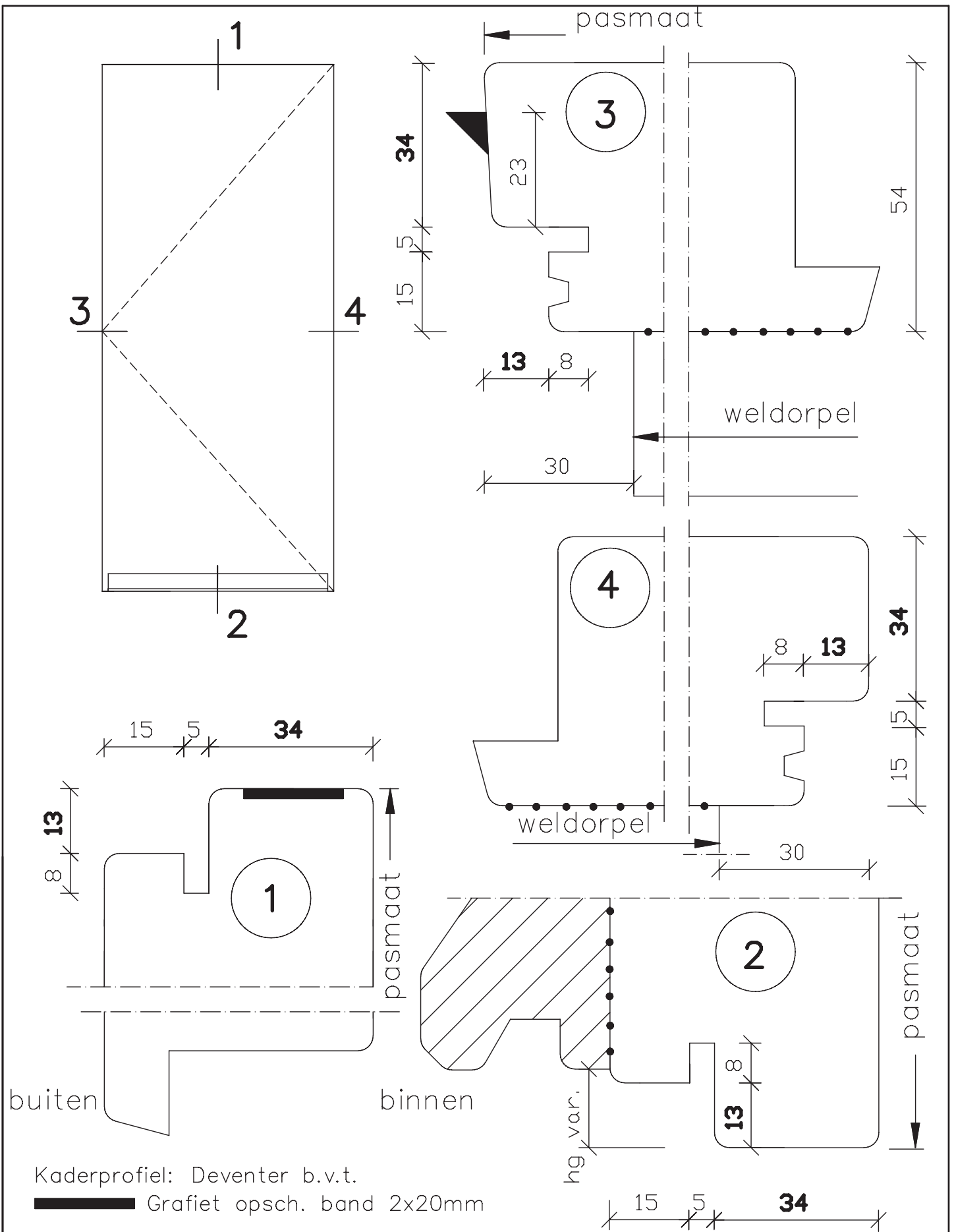

maten
in mm

sept.
2013

pas- en arm
met kader
30 min. b.v.t.
-indicatief-
54mm dik
binnendraaiend

Blad:
956

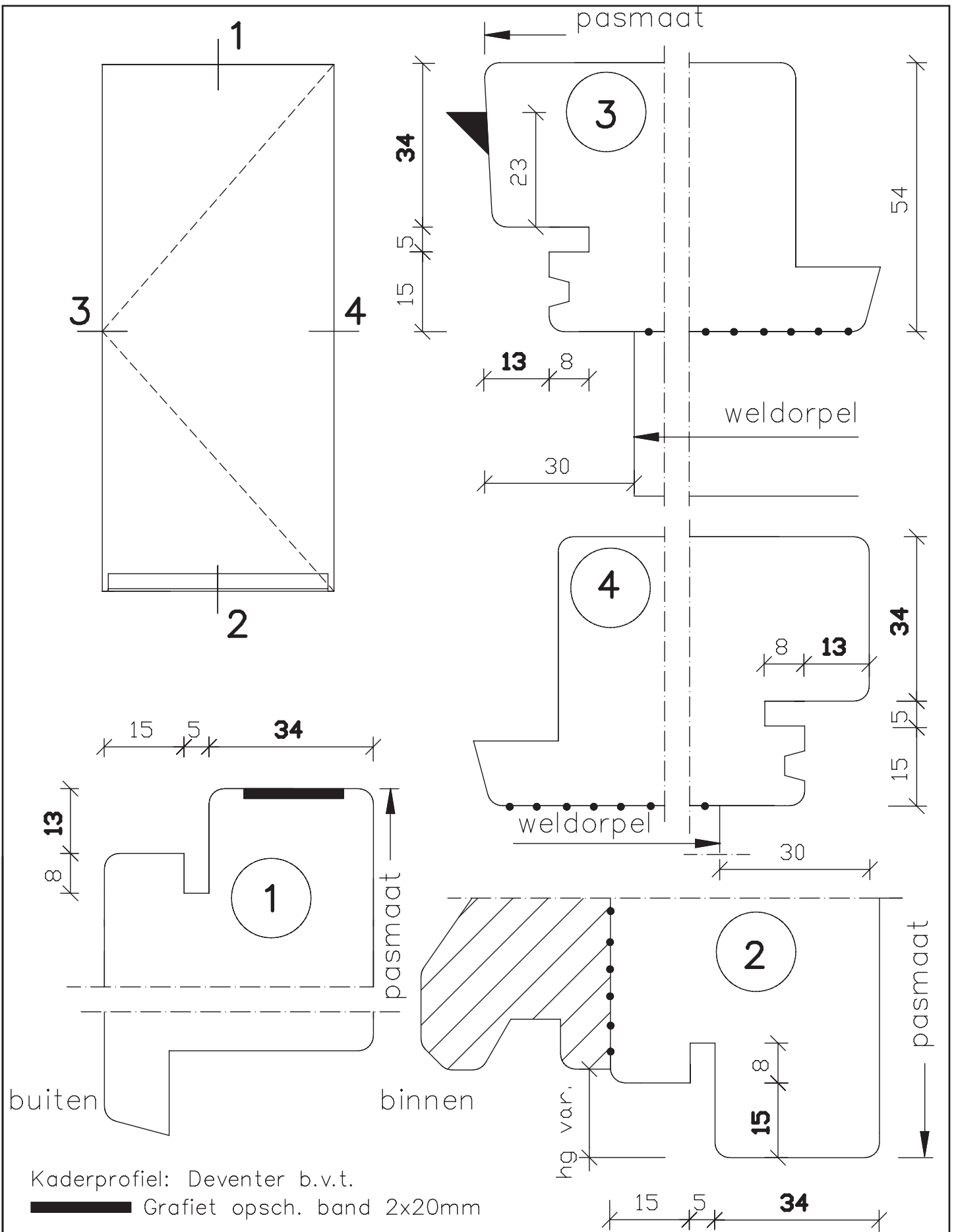

maten
in mm

sept.
2013

pas- en arm
met kader
30 min. b.v.t.
-indicatief-
54mm dik
binnendraaiend

Blad:
956
H

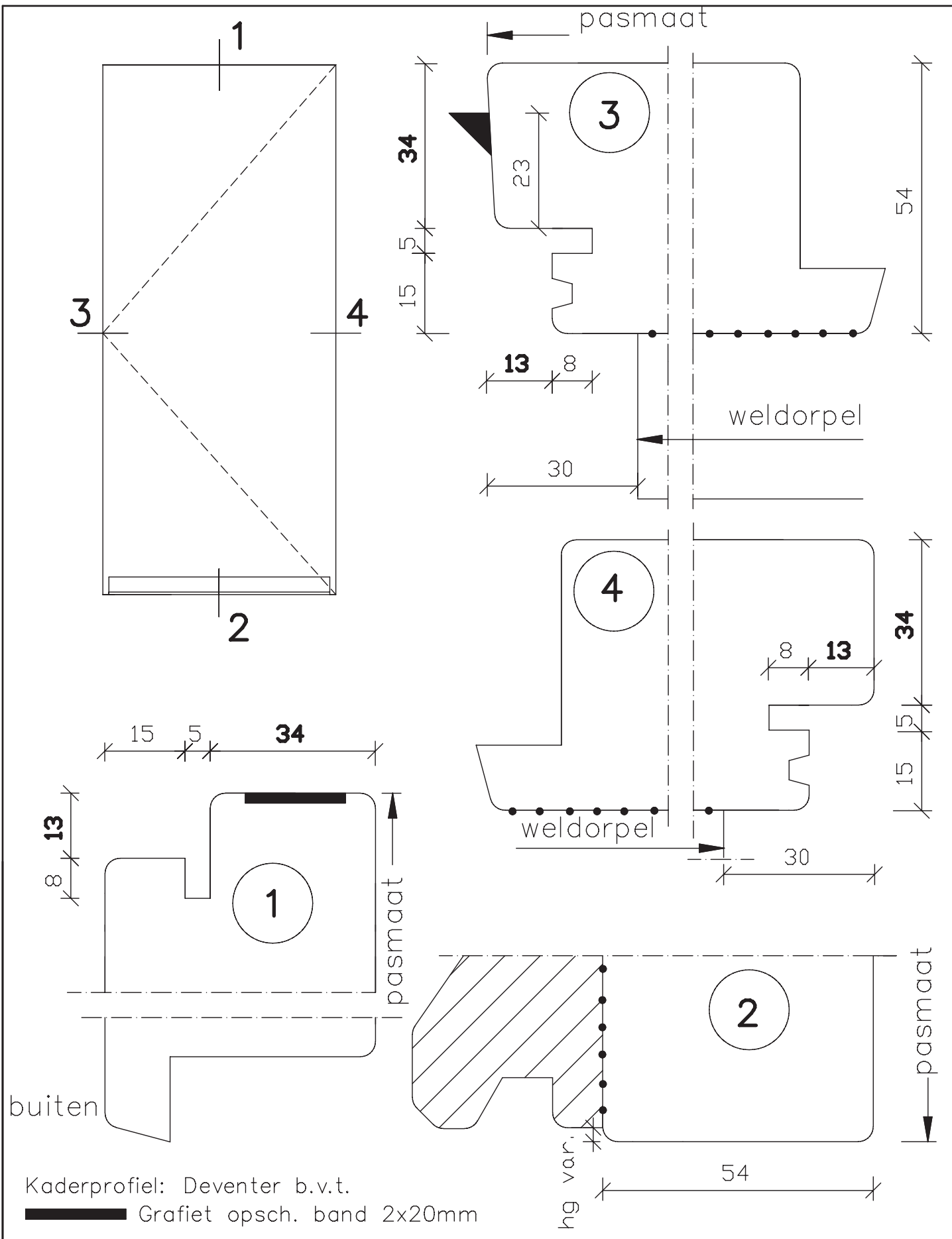

	pas- en arm met kader 30 min. b.v.t. -indicatief- 54mm dik binnendraaiend	Blad: 956 S
maten in mm		
sept. 2013		

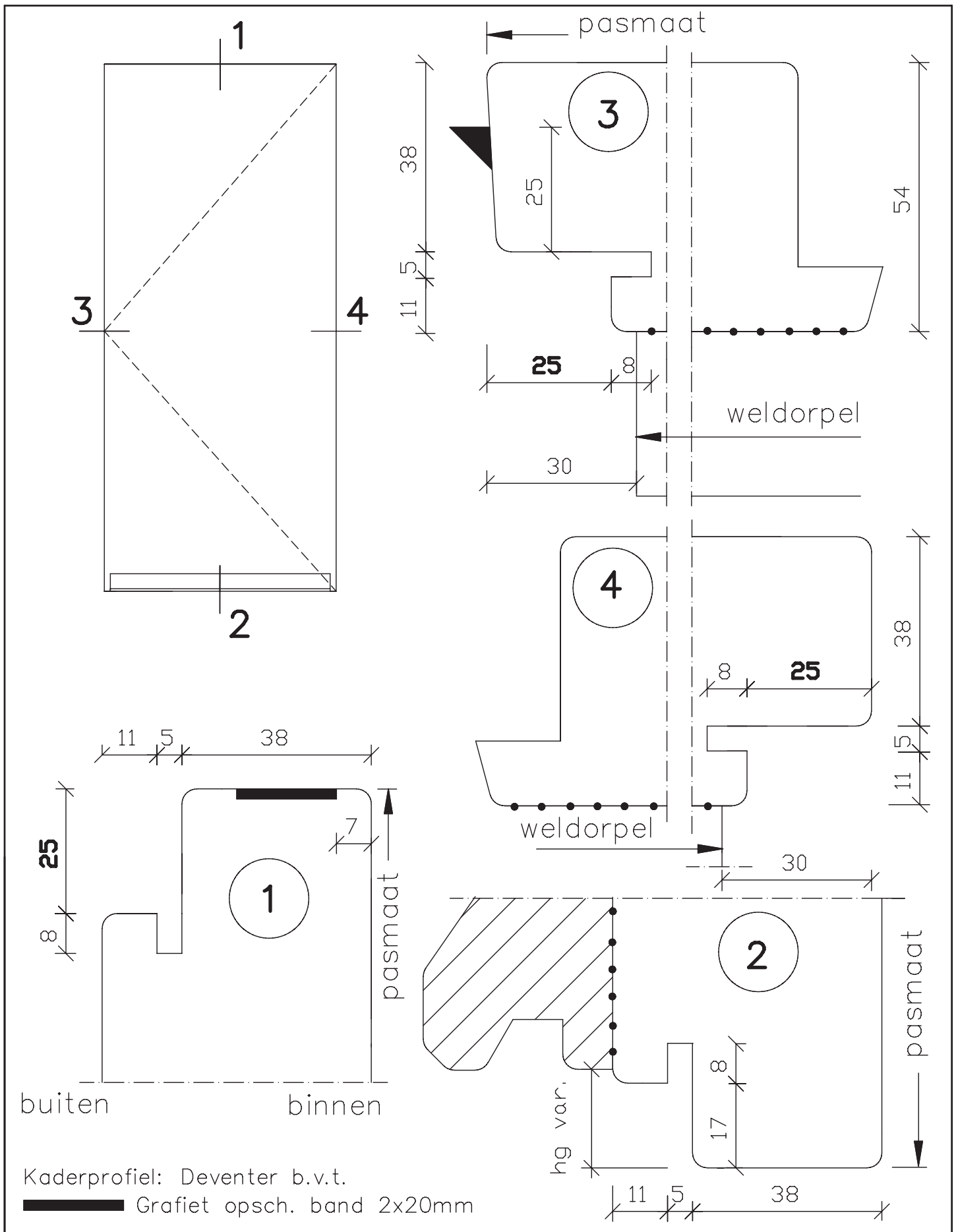

Kaderprofiel: Deventer b.v.t.
 Grafiet opsch. band 2x20mm



	pas- en arm met kader 30 min. b.v.t.	Blad: 957
maten in mm	54mm dik binnendraaiend	
sept. 2013		

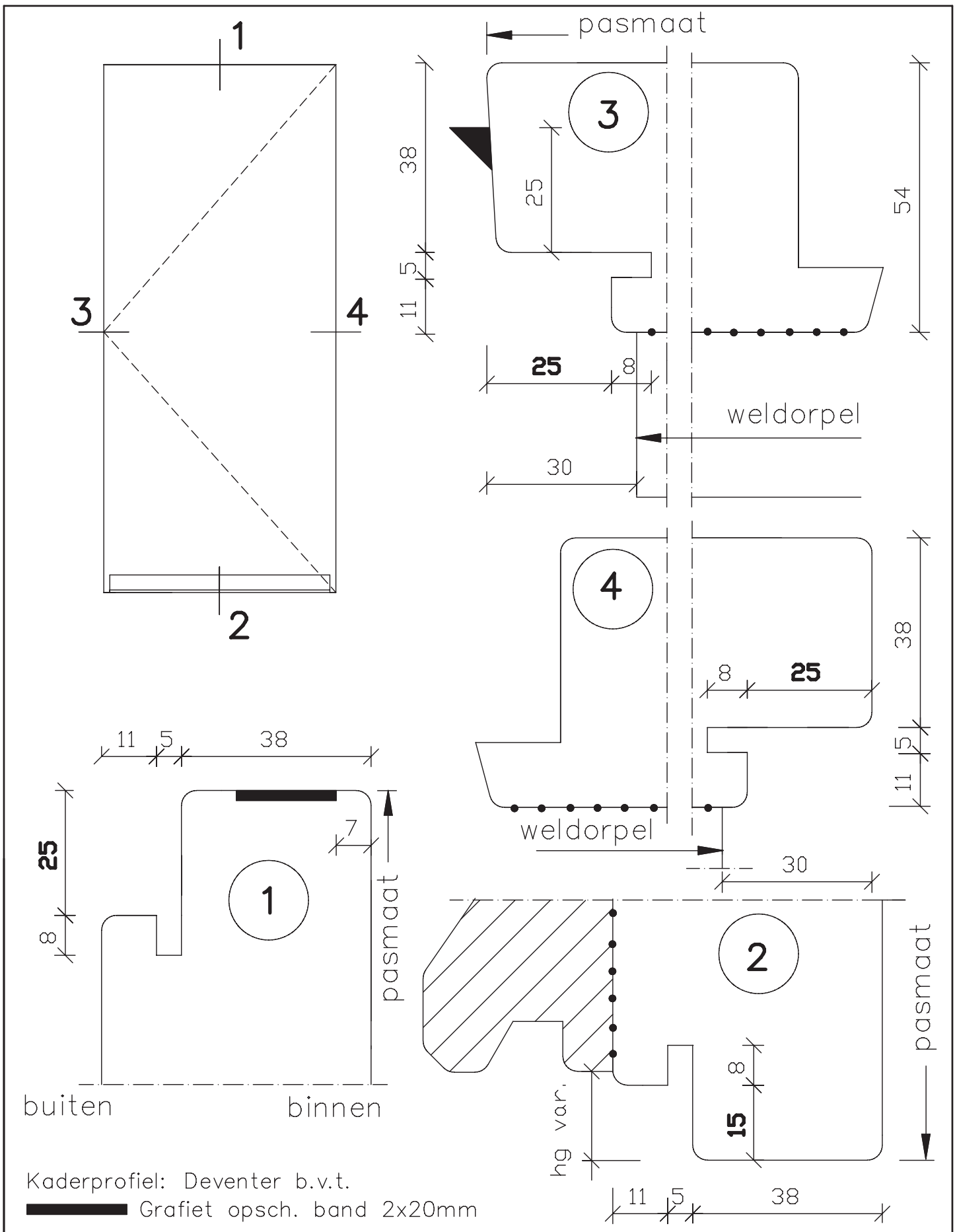

Kaderprofiel: Deventer b.v.t.
█ Grafiet opsch. band 2x20mm



	pas- en arm met kader 30 min. b.v.t.	Blad: 957 H
maten in mm	54mm dik binnendraaiend	
sept. 2013		

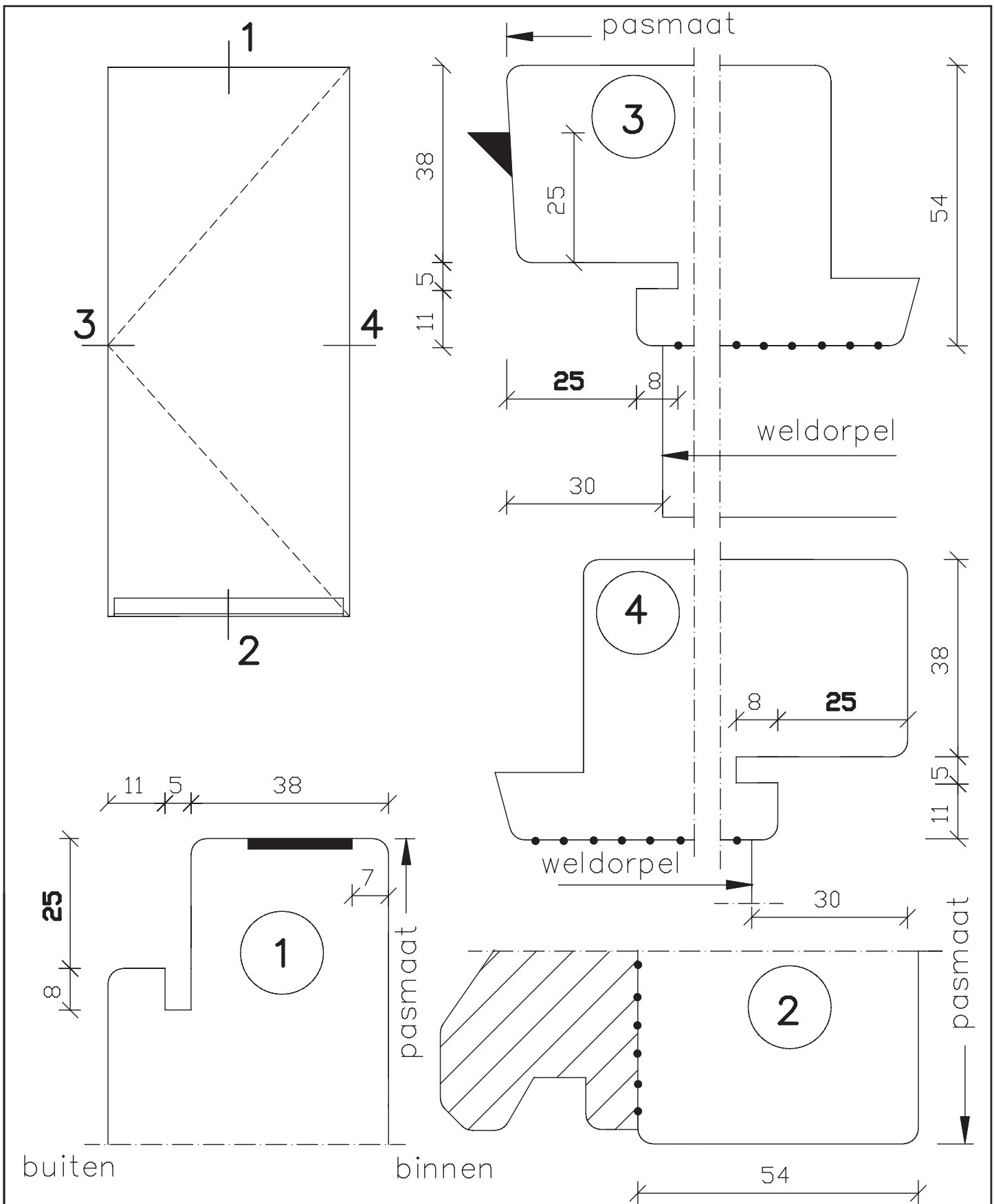

Kaderprofiel: Deventer b.v.t.

Grafiet opsch. band 2x20mm



	pas- en arm met kader 30 min. b.v.t.	Blad: 957
maten in mm	54mm dik binnendraaiend	S
sept. 2013		